

# SK 300



Instruction manual



# Contents

<b>Important safety instructions</b> .....	2
<b>The SK 300 G3 bodypack transmitter</b> .....	3
The frequency bank system.....	3
Areas of application.....	4
<b>Delivery includes</b> .....	5
<b>Product overview</b> .....	6
Overview of the SK 300 G3 bodypack transmitter.....	6
Overview of the displays .....	7
<b>Putting the bodypack transmitter into operation</b> .....	8
Inserting the batteries/accupack.....	8
Charging the accupack .....	8
Connecting the microphone cable/instrument cable....	8
Attaching and positioning the microphones .....	9
Attaching the bodypack transmitter to clothing .....	10
<b>Using the bodypack transmitter</b> .....	11
Switching the bodypack transmitter on/off .....	11
Deactivating the lock mode temporarily.....	13
Muting the audio signal or deactivating the RF signal.....	14
Selecting a standard display.....	16
<b>Using the operating menu</b> .....	17
The buttons .....	17
Overview of the operating menu .....	18
Working with the operating menu .....	19
<b>Adjusting settings via the operating menu</b> .....	21
The main menu "Menu" .....	21
The extended menu "Advanced Menu".....	23
<b>Synchronizing the bodypack transmitter with a receiver</b> .....	29
Synchronizing the bodypack transmitter with the receiver – individual operation.....	29
Synchronizing bodypack transmitters with receivers – multi-channel operation .....	29
<b>Cleaning the bodypack transmitter</b> .....	30
<b>Recommendations and tips</b> .....	31
<b>If a problem occurs ...</b> .....	32
<b>Specifications</b> .....	33
Connector assignment .....	34
Polar diagrams and frequency response curves of the microphones.....	35



An animated instruction manual can be viewed on the SK 300 G3 product page on our website at [www.sennheiser.com](http://www.sennheiser.com).

# Important safety instructions

- Read this instruction manual.
- Keep this instruction manual. Always include this instruction manual when passing the product on to third parties.
- Heed all warnings and follow all instructions in this instruction manual.
- Use only a cloth for cleaning the product.
- Do not place the product near any heat sources such as radiators, stoves, or other devices (including amplifiers) that produce heat.
- Only use attachments/accessories specified by Sennheiser.
- Refer all servicing to qualified service personnel. Servicing is required if the product has been damaged in any way, liquid has been spilled, objects have fallen inside, the product has been exposed to rain or moisture, does not operate properly or has been dropped.
- **WARNING:** To reduce the risk of short circuits, do not use the product near water and do not expose it to rain or moisture.

## Intended use

Intended use of the ew 300 G3 series products includes:

- having read these instructions especially the chapter "Important safety instructions",
- using the products within the operating conditions and limitations described in this instruction manual.

"Improper use" means using the products other than as described in this instruction manual, or under operating conditions which differ from those described herein.

# The SK 300 G3 bodypack transmitter

This bodypack transmitter is part of the evolution wireless series generation 3 (ew G3). With this series, Sennheiser offers high-quality state-of-the-art RF transmission systems with a high level of operational reliability and ease of use. Transmitters and receivers permit wireless transmission with studio-quality sound.

Features of the evolution wireless 300 G3 series:

- Optimized PLL synthesizer and microprocessor technology
- HDX noise reduction system
- Pilot tone squelch control
- True diversity technology
- Switching bandwidth of 42 MHz
- Increased immunity to intermodulation and interferences in multi-channel operation

## The frequency bank system

The bodypack transmitter is available in 7 UHF frequency ranges with 1,680 transmission frequencies per frequency range:

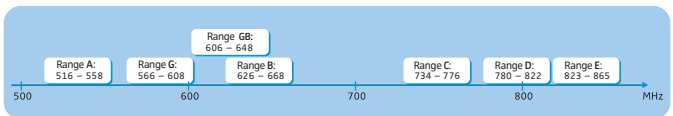

Each frequency range (A–E, G, GB) offers 26 frequency banks with up to 24 channels each:

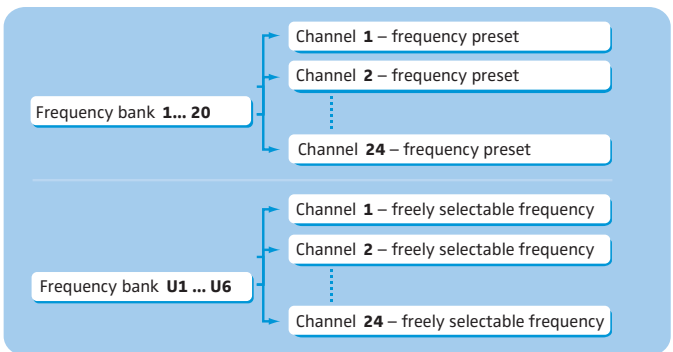

Each of the channels in the frequency banks “1” to “20” has been factory-preset to a fixed frequency (frequency preset).

The factory-preset frequencies within one frequency bank are intermodulation-free. These frequencies cannot be changed.

For an overview of the frequency presets, please refer to the supplied frequency information sheet. Updated versions of the frequency information sheet can be downloaded

## The SK 300 G3 bodypack transmitter

from the SK 300 G3 product page on our website at [www.sennheiser.com](http://www.sennheiser.com).

The frequency banks “U1” to “U6” allow you to freely select and store frequencies. It might be that these frequencies are **not** intermodulation-free.

## Areas of application

The bodypack transmitter can be combined with the EM 300 G3 rack-mount receiver.

The EM 300 G3 rack-mount receiver is available in the same UHF frequency ranges and is equipped with the same frequency bank system with factory-preset frequencies. This has the advantage that

- a transmission system is ready for immediate use after switch-on,
- several transmission systems can be operated simultaneously on the preset frequencies without causing intermodulation interference.

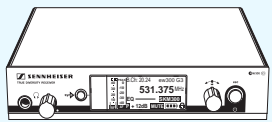
Transmitter	Combinable with	Receiver
 SK 300 G3	<ul style="list-style-type: none"><li>• Clip-on microphones: ME 2, ME 4</li><li>• Headmics: ME 3</li><li>• Line cable: CL 2</li></ul>	 EM 300 G3

Overview of the microphones and line cables:

Microphone/line cable	Microphone type	Pick-up pattern
ME 2 clip-on microphone	pre-polarized condenser microphone	○ – omni
ME 4 clip-on microphone		◐ – cardioid
ME 3 headmic		◐ – cardioid
CL 2 line cable	–	–

# Delivery includes

The packaging contains the following items:

- 1 SK 300 G3 bodypack transmitter
- 2 AA size batteries, 1.5 V
- 1 instruction manual
- 1 frequency information sheet
- 1 supplement "Framework requirements and restrictions on frequency usage"

# Product overview

## Overview of the SK 300 G3 bodypack transmitter

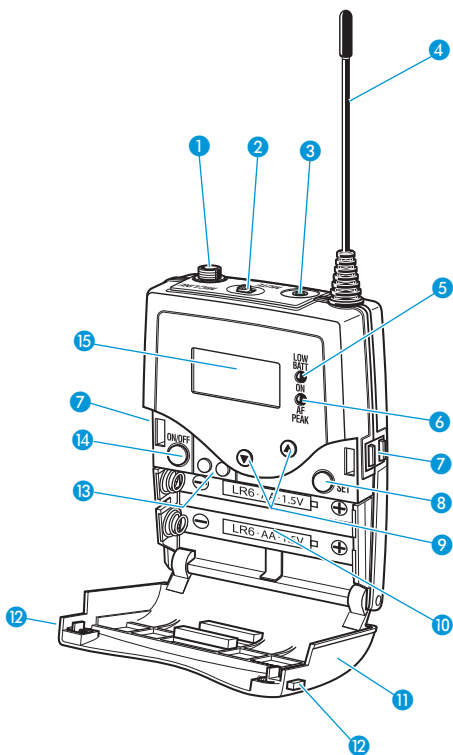

- 1 Microphone/instrument input (MIC/LINE), 3.5 mm jack socket, lockable
- 2 MUTE switch
- 3 Socket for connection of RMS 1 external mute switch, 2.5 mm jack socket
- 4 Antenna
- 5 Operation and battery status indicator, red LED (lit = ON/flashing = LOW BATTERY)
- 6 Audio overmodulation indicator, yellow LED (lit = AF PEAK)
- 7 Charging contacts
- 8 SET button
- 9 UP/DOWN button ▲/▼
- 10 Battery compartment
- 11 Battery compartment cover
- 12 Battery compartment catches
- 13 Infra-red interface
- 14 ON/OFF button with ESC function (cancel)
- 15 Display panel, backlit in orange





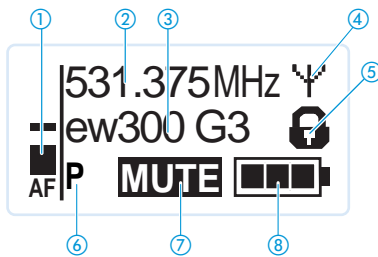

## Overview of the displays

After switch-on, the bodypack transmitter displays the standard display “**Frequency/Name**”. For further illustrations and examples of the different standard displays, refer to page 16.

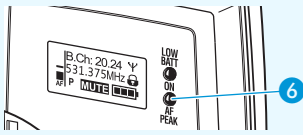
The display backlighting is automatically reduced after approx. 20 seconds.

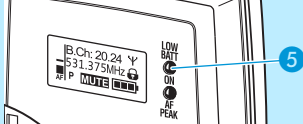

Display	Meaning
① Audio level “AF”	<p>Modulation of the bodypack transmitter with peak hold function</p> <p>When the transmitter’s audio input level is excessively high, the “AF” display shows full deflection and, in addition, the yellow <b>AF PEAK LED ⑥</b> lights up:</p> 
② Frequency	Current transmission frequency
③ Name	Freely selectable name of the transmitter
④ Transmission icon	RF signal is being transmitted
⑤ Lock mode icon	Lock mode is activated
⑥ “P” (pilot tone)	Pilot tone transmission is activated
⑦ “MUTE”	Audio signal is muted/ RF signal is deactivated
⑧ Battery status	<p>Charge status:</p> <ul style="list-style-type: none"> <li> approx. 100%</li> <li> approx. 70%</li> <li> approx. 30%</li> <li> charge status is critical, the red <b>LOW BATTERY LED ⑤</b> is flashing:</li> </ul> 

# Putting the bodypack transmitter into operation

## Inserting the batteries/accupack

For powering the bodypack transmitter, you can either use two 1.5 V AA size batteries or the rechargeable Sennheiser BA 2015 accupack (optional accessory).

- ▶ Open the battery compartment by pushing the two catches **12** in the direction of the arrows and open the cover **11**.

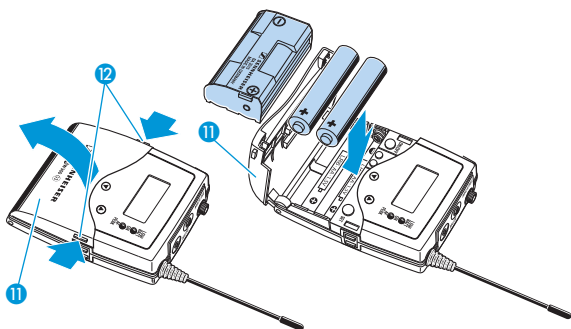

- ▶ Insert the two batteries or the accupack as shown above. Please observe correct polarity when inserting the batteries/accupack.
- ▶ Close the battery compartment. The battery compartment cover **11** locks into place with an audible click.

## Charging the accupack

To charge the BA 2015 accupack (optional accessory) installed in the bodypack transmitter:

- ▶ Insert the bodypack transmitter into the L 2015 charger L 2015 (optional accessory).



The L 2015 charger can only charge the combination BA 2015 accupack/bodypack transmitter. Standard batteries (primary cells) or individual rechargeable battery cells cannot be charged.

## Connecting the microphone cable/ instrument cable

The audio input is designed for the connection of both condenser microphones and other audio sources. DC powering of the condenser microphones is via the **MIC/LINE** socket **1** (3.5 mm jack socket).

- ▶ Use one of the recommended Sennheiser microphones or the CL 2 line cable (optional accessory).
- ▶ Connect the 3.5 mm jack plug **16** from the Sennheiser microphone or line cable to the **MIC/LINE** socket **1** (3.5 mm jack socket).

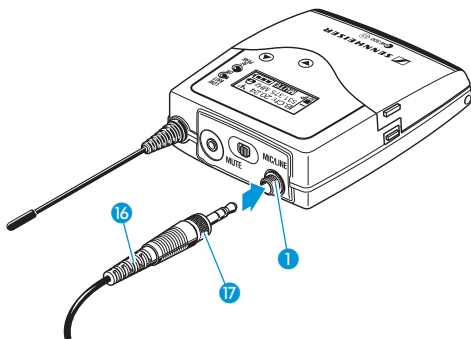

- ▶ Lock the 3.5 mm jack plug by screwing down the coupling ring 17.
- ▶ Via the operating menu, adjust the sensitivity of the microphone/line input (see “Adjusting the input sensitivity – “Sensitivity”” on page 21).

## Attaching and positioning the microphones

### ME 2

- ▶ Use the microphone clip 18 to attach the microphone to clothing (e.g. tie, lapel).
- ▶ Attach the ME 2 microphone as close as possible to the sound source.



The ME 2 clip-on microphone has an omni-directional pick-up pattern. It is therefore not necessary to position it precisely.

### ME 3

- ▶ Adjust the ME 3 headmic so that a comfortable and secure fit is ensured.

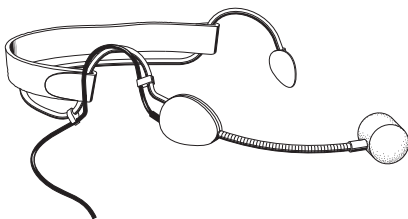

The ME 3 headmic has a cardioid pick-up pattern.

- ▶ Position the microphone so that its sound inlet is directed towards the sound source (e.g. mouth).

### ME 4

- ▶ Use the microphone clip **18** to attach the microphone to clothing (e.g. tie, lapel).

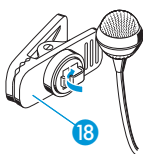

The ME 4 clip-on microphone has a cardioid pick-up pattern.

- ▶ Position the ME 4 so that its sound inlet is directed towards the sound source (e.g. mouth).

## Attaching the bodypack transmitter to clothing

You can use the belt clip **19** to attach the bodypack transmitter to clothing (e.g. belt, waistband).

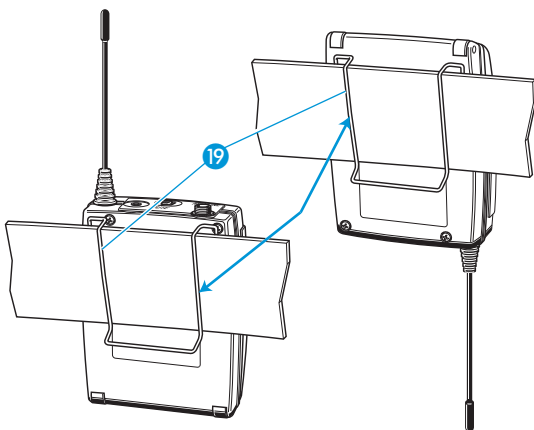

The belt clip is detachable so that you can also attach the bodypack transmitter with the antenna pointing downwards. To do so, withdraw the belt clip **19** from its fixing points and attach it the other way round.

The belt clip **19** is secured so that it cannot slide out of its fixing points accidentally.

To detach the belt clip:

- ▶ Lift the belt clip as shown.

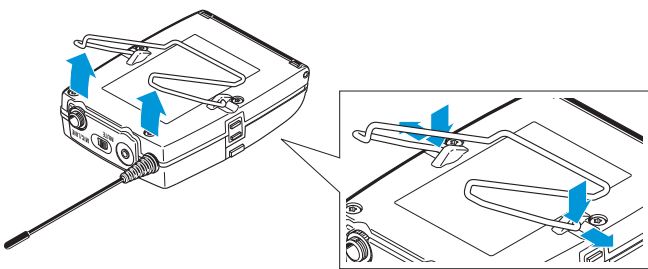

- ▶ Press down the belt clip at one fixing point and pull it out of the transmitter housing.
- ▶ Repeat for the other side.

# Using the bodypack transmitter

To establish a transmission link, proceed as follows:

1. Switch the bodypack transmitter on (see next section)
2. Switch the receiver on (see the instruction manual of the receiver).

The transmission link is established and the display backlighting of the receiver changes from red to orange.



It is vital to observe the notes on frequency selection on page 29.

If you cannot establish a transmission link between bodypack transmitter and receiver, refer to the chapter “Synchronizing the bodypack transmitter with the receiver – individual operation” on page 29.

## Switching the bodypack transmitter on/off

- ▶ Push the two catches **12** and open the battery compartment cover **11**.

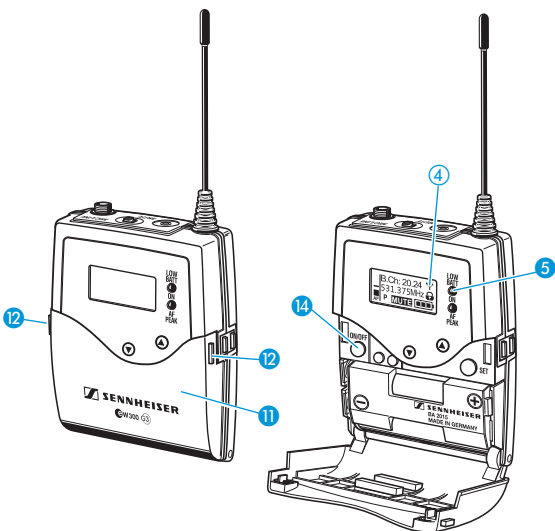

To switch the bodypack transmitter **on** (online operation):

ON/OFF



- ▶ Briefly press the ON/OFF button **14**.

The “**Frequency/Name**” standard display appears on the display panel. The red ON LED **5** lights up and the transmission icon **4** is displayed. The bodypack transmitter transmits an RF signal.

To switch the bodypack transmitter on and to **deactivate the RF signal on switch-on** (offline operation):

ON/OFF





- ▶ Keep the ON/OFF button pressed until “**RF Mute Off?**” appears on the display panel.



- ▶ Press the UP/DOWN button **▲/▼**.





“**RF Mute On?**” appears on the display panel.

-  ▶ Press the **SET** button.
- The transmission frequency is displayed but the bodypack transmitter does not transmit an RF signal. The transmission icon  is not displayed. When the pilot tone function is activated on both bodypack transmitter and receiver, and the display has been activated via the “Warnings” menu on the receiver, “RF Mute” (backlit in red) appears alternately with the standard display on the receiver’s display panel.







- 
-  Use this function to save battery power or to prepare a bodypack transmitter for use during live operation without causing interference to existing transmission links.
- 

### To activate the RF signal:

-  ▶ Briefly press the **ON/OFF** button.
- “RF Mute On?” appears on the display panel.
-  ▶ Press the UP/DOWN button .
- “RF Mute Off?” appears on the display panel.
-  ▶ Press the **SET** button.
- The RF signal is activated and the transmission icon  is displayed again.

### To switch the bodypack transmitter off:



- ▶ If necessary, deactivate the lock mode (see next chapter).
-  ▶ Keep the **ON/OFF** button  pressed until “OFF” appears on the display panel. The red **ON LED**  goes off and the display panel turns off.

- 
-  When in the operating menu, pressing the **ON/OFF** button  will cancel your entry (ESC function) and return you to the current standard display.
-

## Deactivating the lock mode temporarily

You can activate or deactivate the automatic lock mode via the “Auto Lock” menu item (see page 23).

If the lock mode is activated, you have to temporarily deactivate it in order to be able to operate the bodypack transmitter:

-  ▶ Press the SET button.  
 “Locked” appears on the display panel.
-  ▶ Press the UP/DOWN button ▲/▼.  
 “Unlock?” appears on the display panel.
-  ▶ Press the SET button.  
 The lock mode is temporarily deactivated.  
 How you are using the bodypack transmitter determines how long the lock mode remains deactivated:

### When you are in the operating menu

The lock mode remains deactivated until you exit the operating menu.

### When one of the standard displays is shown

The lock mode is automatically activated after 10 seconds.

The lock mode icon ⑤ flashes prior to the lock mode being activated again.



## Muting the audio signal or deactivating the RF signal

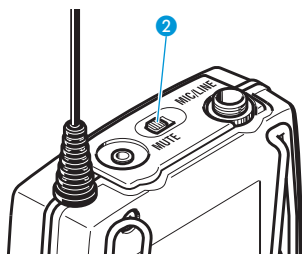

The **MUTE** switch ② allows you to mute the audio signal or to deactivate the RF signal.

Via the “**Mute Mode**” menu item, you can set the desired function of the **MUTE** switch ② (see page 25):

Setting	Slide the MUTE switch ② ...	Function
“AF On/Off”	... to the left (position <b>MUTE</b> )	Mutes the audio signal
	... to the right	Unmutes the audio signal
“RF On/Off”	... to the left (position <b>MUTE</b> )	Deactivates the RF signal (offline operation)
	... to the right	Activates the RF signal (online operation)
“Disabled”	No function	

► From the “**Mute Mode**” menu item, select the desired setting (see page 25).



The settings “**Push to mute**” and “**Push to talk**” are only available in conjunction with the RMS 1 external mute switch (see page 25, optional accessory).

► Exit the operating menu.

► Slide the **MUTE** switch ② to the left, to the position **MUTE**.  
The bodypack transmitter reacts as indicated in the table.

The current state of the muting function or the RF signal is displayed on the display panel of the bodypack transmitter.



An additional display of the muting function appears on the receiver’s display panel when

- the pilot tone function is activated on both bodypack transmitter and receiver  
and, in addition,
- this display has been activated via the “**Warnings**” menu on the receiver (see the instruction manual of the receiver).



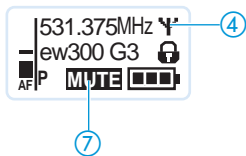

### Audio signal is muted

Transmitter's display panel: "MUTE" ⑦ is displayed

Receiver's display panel: "TX Mute" is displayed\*

\* only when activated on the receiver (see previous section)

### Audio signal is activated (muting is deactivated)

Transmitter's display panel: "MUTE" ⑦ is not displayed

Receiver's display panel: "TX Mute" is not displayed

### RF signal is deactivated

Transmitter's display panel: transmission icon ④ is not displayed,  
"MUTE" ⑦ is displayed

Receiver's display panel: "RF Mute" is displayed\*

\* only when activated on the receiver (see previous section)

### RF signal is activated

Transmitter's display panel: transmission icon ④ is displayed,  
"MUTE" ⑦ is not displayed

Receiver's display panel: "RF Mute" is not displayed



You can also deactivate the RF signal on switch-on. For more information, refer to the chapter "Switching the bodypack transmitter on/off" on page 13.

Using the ON/OFF button, you can also activate/deactivate the RF signal during operation.

To do so, briefly press the ON/OFF button and proceed as described on page 13.

## Selecting a standard display

- ▼▲ ▶ Press the UP/DOWN button ▲/▼ to select a standard display:

Contents of the display	Selectable standard display
<p>531.375MHz Y ew300 G3 AF1 P MUTE [Battery Icon]</p>	"Frequency/Name"
<p>B.Ch: 20.24 Y 531.375MHz AF1 P MUTE [Battery Icon]</p>	"Channel/Frequency"
<p>ew300 G3 Y B.Ch: 20.24 AF1 P MUTE [Battery Icon]</p>	"Name/Channel"

# Using the operating menu

A special feature of the Sennheiser ew G3 series is the consistent, intuitive menu structure of transmitters and receivers. As a result, adjustments to the settings can be made quickly – even in stressful situations, for example on stage or during a live show or presentation.





Make use of the possibility to adjust settings via the operating menu of the receiver and to transfer these settings to the bodypack transmitter.



For more information on how to transfer settings to the bodypack transmitter, refer to the instruction manual of your receiver. The relevant information is marked with the sync icon.

## The buttons

Button	Function of the button
Press the <b>ON/OFF</b> button 	<ul style="list-style-type: none"> <li>• Switches the bodypack transmitter on and off</li> <li>• Cancels the entry and returns to the current standard display (ESC function)</li> <li>• Activates/deactivates the RF signal (special function, see page 13)</li> </ul>
Press the <b>SET</b> button 	<ul style="list-style-type: none"> <li>• Changes from the current standard display to the operating menu</li> <li>• Calls up a menu item</li> <li>• Enters a submenu</li> <li>• Stores the settings and returns to the operating menu</li> </ul>
Press the <b>UP/DOWN</b> button ▲/▼ 	<ul style="list-style-type: none"> <li>• Selects a standard display</li> <li>• Changes to the next/previous menu item</li> <li>• Changes the setting of a menu item</li> </ul>

## Overview of the operating menu

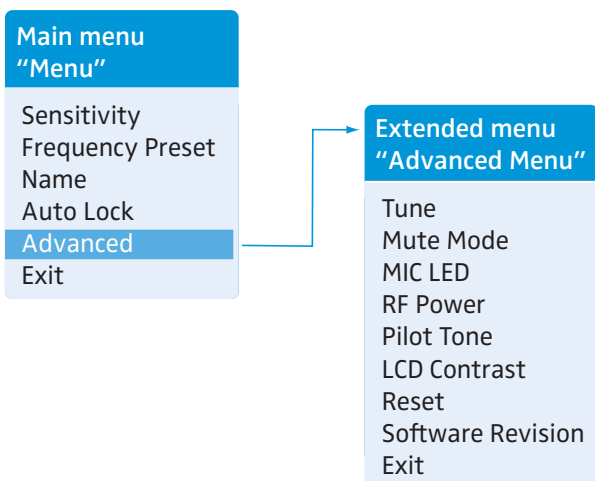

Display	Function of the menu item
---------	---------------------------

### Main menu "Menu"

Sensitivity	Adjusts the sensitivity "AF" (see page 21)
Frequency Preset	Sets the frequency bank and the channel (see page 22)
Name	Enters a freely selectable name (see page 22)
Auto Lock	Activates/deactivates the lock mode (see page 23)
Advanced	Calls up the extended menu "Advanced Menu" (see page 23)
Exit	Exits the operating menu and returns to the current standard display

### Extended menu "Advanced Menu"

Tune	Sets the transmission frequencies for the frequency banks "U1" to "U6" (see page 23) Sets the channel and the transmission frequency for the frequency banks "U1" to "U6" (see page 24)
Mute Mode	Sets the mode for the MUTE switch (see page 25)
MIC LED	Sets the behavior of the STATUS LED of the RMS 1 external mute switch (see page 26)
RF Power	Adjusts the transmission power (see page 26)
Pilot Tone	Activates/deactivates the pilot tone transmission (see page 27)
LCD Contrast	Adjusts the contrast of the display panel (see page 27)
Reset	Resets the settings made in the operating menu (see page 27)

Display	Function of the menu item
Software Revision	Displays the current software revision (see page 28)
Exit	Exits the extended menu "Advanced Menu" and returns to the main menu

## Working with the operating menu



If the lock mode is activated, you have to deactivate it in order to be able to work with the operating menu (see page 13).

By way of example of the "Sensitivity" menu, this section describes how to use the operating menu.

### Changing from a standard display to the operating menu



- ▶ Press the SET button.  
The current standard display is replaced by the main menu.  
The last called up menu item is displayed.

### Selecting a menu item

- ▶ Press the UP/DOWN button ▲/▼ to change to the "Sensitivity" menu item.  
The current setting of the selected menu item is displayed:

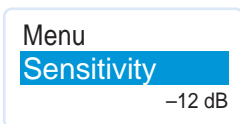

### Changing and storing settings

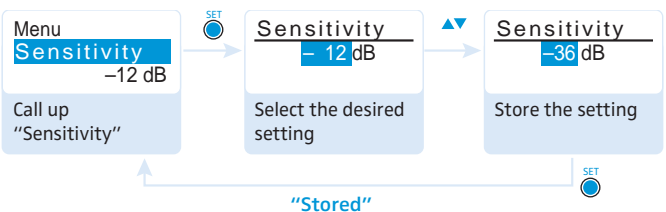

- ▶ Press the SET button to call up the menu item.



- ▶ Press the UP/DOWN button ▲/▼ to adjust the input sensitivity.



- ▶ Press the SET button to store the setting.

### Canceling an entry



- ▶ Press the ON/OFF button to cancel the entry.  
The current standard display appears on the display panel.

To subsequently return to the last edited menu item:

-  Press the **SET** button repeatedly until the last edited menu item appears.

### Exiting a menu item

-  Change to the “**Exit**” menu item.

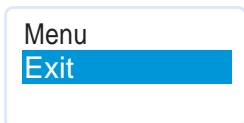

-  Confirm your selection.  
You return to the next higher menu level or you exit the operating menu and return to the current standard display.

To directly return to the current standard display:

-  Press the **ON/OFF** button.

# Adjusting settings via the operating menu



Make use of the possibility to adjust settings via the operating menu of your receiver and to transfer these settings to the bodypack transmitter.



For more information, refer to the instruction manual of the receiver. The relevant information is marked with the sync icon.

## The main menu "Menu"

### Adjusting the input sensitivity – "Sensitivity"

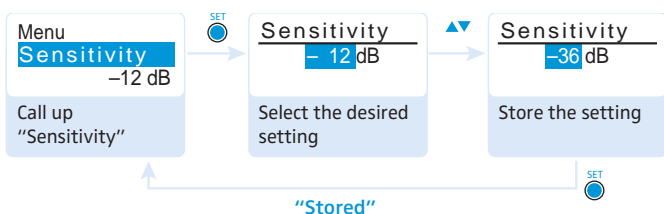

Adjustment range: 0 to –60 dB, adjustable in steps of 3 dB



The audio level display "AF" ① always indicates the audio level, even if the bodypack transmitter is muted, e.g. allowing you to check the adjusted sensitivity before live operation.

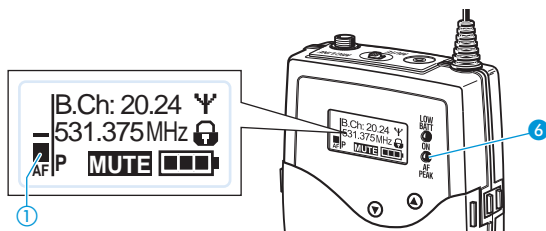

Input sensitivity is adjusted ...	Effect/display
... too high	Close talking distances, speakers with loud voices or loud music passages cause overmodulation in the transmission link. The yellow AF PEAK LED ⑥ lights up. The audio level display "AF" ① shows full deflection for the duration of the overmodulation.
... correctly	The audio level display "AF" ① shows full deflection only during the loudest passages.
... too low	The transmission link is undermodulated. This results in a signal with high background noise.

## Adjusting settings via the operating menu

The following figures are a guide to the best settings:

Transmission situation	Sensitivity setting
Loud music/vocals	-30 to -21 dB
Presentations	-21 to 0 dB

### Selecting the frequency bank and the channel manually – “Frequency Preset”

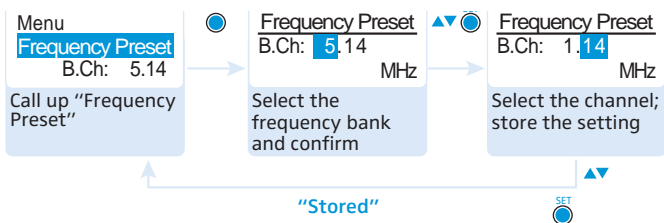

When you are in the “Frequency Preset” menu item, the RF signal is deactivated.

Overview of the frequency banks and channels:

Frequency bank	Channels	Type
“1” to “20”	up to 24 per frequency bank	System bank: frequencies are factory-preset
“U1” to “U6”	up to 24 per frequency bank	User bank: frequencies are freely selectable



When setting up multi-channel systems, please observe the following:

Only the factory-preset frequencies within one frequency bank are intermodulation-free (see page 29).

Bodypack transmitter and receiver of a transmission link have to be set to the same frequency.

- ▶ It is vital to observe the notes on frequency selection on page 29.

### Entering a name – “Name”

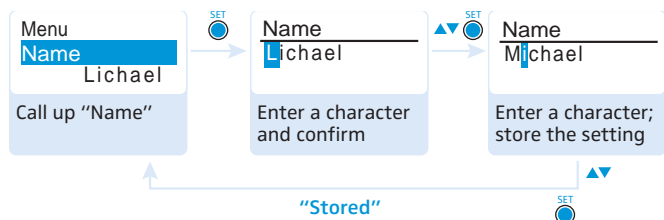

Via the “Name” menu, you can enter a freely selectable name (e.g. the name of the performer) for the bodypack transmitter.

The name can be displayed on the standard displays “Frequency/Name” and “Name/Channel”. The name can consist of up to 8 characters such as:

- letters (without pronunciation marks),



- numbers from 0 to 9,
- special characters and spaces.

To enter a name, proceed as follows:

- ▶ Press the UP/DOWN button ▲/▼ to select a character.



- ▶ Press the SET button to change to the next segment/character or to store the complete entry.

### Activating/deactivating the automatic lock mode – “Auto Lock”

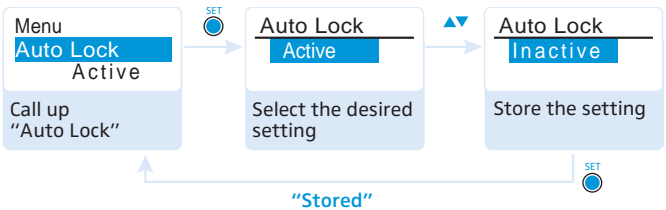

The lock mode prevents that the bodypack transmitter is accidentally switched off or programmed during operation. The lock mode icon ⑤  on the current standard display indicates that the lock mode is activated.

- ▶ Press the UP/DOWN button ▲/▼ to select the desired setting.

For information on how to use the lock mode, refer to page 13.

## The extended menu “Advanced Menu”

### Setting transmission frequencies and frequency banks – “Tune”



When you have selected one of the system banks and then select the “Tune” menu, the bodypack transmitter automatically switches to channel 1 of the frequency bank “U1”. In this case, “U1.1” briefly appears on the display panel.

Upon delivery, the channels of the frequency banks “U1” to “U6” are not assigned a transmission frequency.

When you are in the “Tune” menu item, the RF signal is deactivated.

Via the “Tune” menu item, you can set a transmission frequency to be stored in the current channel or you can select a different channel in one of the frequency banks “U1” to “U6” and assign this channel a transmission frequency.



It is vital to observe the notes on frequency selection on page 29.

### Setting a transmission frequency for the current channel

- ▶ Press the UP/DOWN button ▲/▼ until the "Tune" menu item appears.

- ▶ Press the SET button.  
The frequency selection appears.

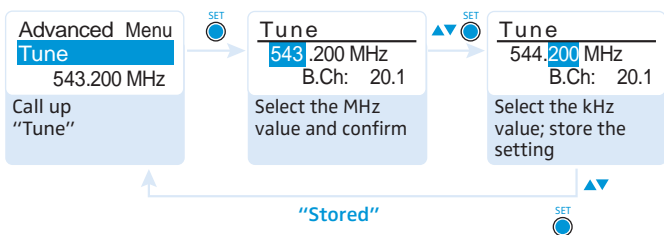

- ▶ Set the desired frequency.

- ▶ Press the SET button.  
Your settings are stored.  
You are back to the operating menu.

### Selecting a frequency bank and a channel and assigning this channel a frequency

- ▶ Press the UP/DOWN button ▲/▼ until the "Tune" menu item appears.

- ▶ Keep the SET button pressed until the frequency bank is highlighted.

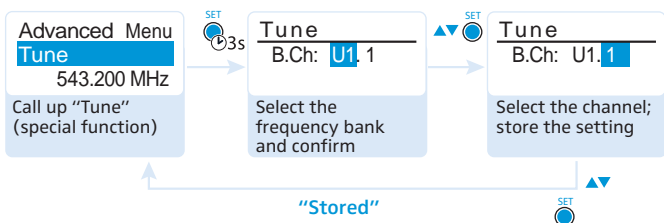

- ▶ Set the desired frequency bank.

- ▶ Press the SET button.  
The channel selection appears.

- ▶ Set the desired channel.

- ▶ Press the SET button.  
The frequency selection appears.

- ▶ Set the desired frequency.

- ▶ Press the SET button.  
Your settings are stored.  
You are back to the operating menu.

## Setting the mode for the MUTE switch and the RMS 1 external mute switch – “Mute Mode”

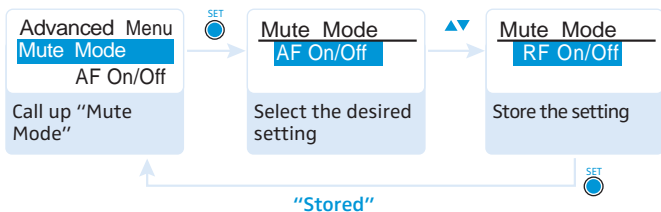

The settings “Push to mute” and “Push to talk” are only available in conjunction with the RMS 1 external mute switch.

Setting	Switch	Function
“AF On/Off”	MUTE switch	If the switch is set to position <b>MUTE</b> , the audio signal is muted.
	RMS 1 external mute switch*	If you press the <b>MIC</b> button of the RMS 1*: The audio signal is muted. If you press the <b>MIC</b> button of the RMS 1* again: The muting is canceled.
“RF On/Off”	MUTE switch	If the switch is set to position <b>MUTE</b> , the RF signal is deactivated.
	RMS 1 external mute switch*	If you press the <b>MIC</b> button of the RMS 1*: The radio signal is deactivated. If you press the <b>MIC</b> button of the RMS 1* again: The RF signal is reactivated.
“Push To Mute”	RMS 1 external mute switch*	The audio signal is muted as long as you press the <b>MIC</b> button of the RMS 1*.
“Push To Talk”**	RMS 1 external mute switch*	The audio signal is activated as long as you press the <b>MIC</b> button of the RMS 1*.
“Disabled”	MUTE switch or RMS 1 external mute switch*	The function is deactivated.

\* optional accessory

\*\* If you select “Push To Talk”, the bodypack transmitter will be muted until the **MIC** button is pressed.



If you connect the RMS 1 external mute switch, you can only set the muting via the RMS 1.

The function of the **MUTE** switch is deactivated during this time.

You can set the behavior of the **STATUS** LED of the RMS 1 external mute switch via the “**MIC LED**” menu item (see next chapter).

For information on how to use the **MUTE** switch ②, refer to page 14.

### Setting the behavior of the **STATUS** LED of the RMS 1 external mute switch – “**MIC LED**”

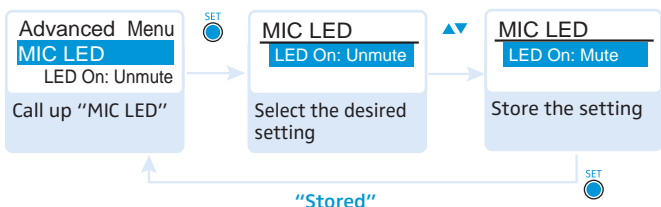

Via the “**MIC LED**” menu item, you can set the behavior of the **STATUS** LED of the RMS 1 external mute switch (optional accessory) according to the settings of the “**Mute Mode**” menu item and the state of the RF signal.

Settings of the MIC LED menu item	<b>STATUS</b> LED of the RMS 1 external mute switch
“LED On: Unmute”	The <b>STATUS</b> LED lights up when the transmitter is transmitting an RF signal or is <b>not</b> muted.
“LED On: Mute”	The <b>STATUS</b> LED lights up when the transmitter is not transmitting an RF signal or is muted.
“Disable LED”	The <b>STATUS</b> LED is off.

### Adjusting the transmission power – “**RF Power**”

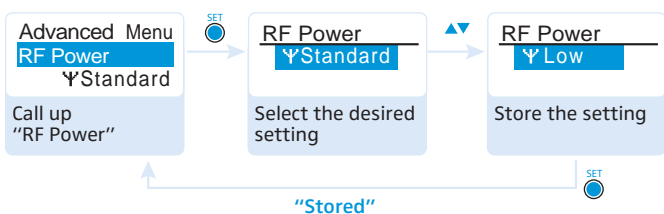

Via the “**RF Power**” menu item, you can adjust the transmission power in two steps.



It is vital to observe the notes on the supplied frequency information sheet.

## Activating/deactivating the pilot tone transmission – “Pilot Tone”

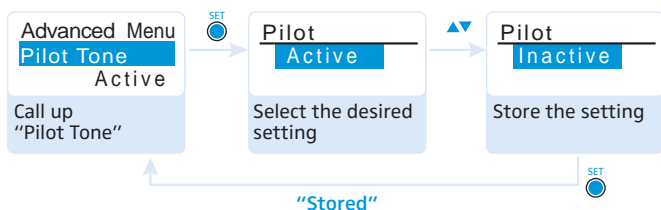

The bodypack transmitter adds an inaudible signal, known as the pilot tone, to the transmitted signal. The receiver detects and evaluates the pilot tone.

The pilot tone supports the receiver’s squelch function (Squelch) and protects against interference due to RF signals from other devices.

Devices of the ew 300 G1 series (generation 1) do not support the pilot tone function. Therefore, please observe the following when combining a bodypack transmitter or receiver of the ew 300 G3 series (generation 3) with devices from an earlier evolution wireless generation:

Transmitter	Receiver	Make sure to ...
ew G3/ew G2	ew G3/ew G2	... activate the pilot tone function on both bodypack transmitter and receiver.
ew G3	ew G1	... deactivate the pilot tone function on the ew 300 G3 bodypack transmitter.
ew G1	ew G3	... deactivate the pilot tone function on the ew 300 G3 receiver.

## Adjusting the contrast of the display panel – “LCD Contrast”

You can adjust the contrast of the display panel in 16 steps.

## Resetting the settings made in the operating menu – “Reset”

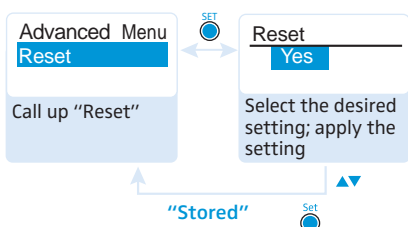

When resetting the settings made in the operating menu, only the selected settings for the pilot tone and for the frequency banks “U1” to “U6” remain unchanged. For an overview of the factory-preset default settings, refer to the supplied frequency information sheet.

### Displaying the software revision – “Software Revision”

You can display the current software revision of the bodypack transmitter.

- ▶ For information on software updates, visit the SK 300 G3 product page at [www.sennheiser.com](http://www.sennheiser.com).

## Synchronizing the bodypack transmitter with a receiver

When synchronizing the bodypack transmitter with a receiver, please observe the following:



- ▶ Only use a transmitter and a receiver from the same frequency range (see the type plate on the transmitter and the receiver).
  - ▶ Make sure that the desired frequencies are listed in the enclosed frequency information sheet.
  - ▶ Make sure that the desired frequencies are approved and legal in your country and, if necessary, apply for an operating license.
- 

### Synchronizing the bodypack transmitter with the receiver – individual operation

Upon delivery, the bodypack transmitter and the receiver are synchronized with each other.

If, however, you cannot establish a transmission link between bodypack transmitter and receiver, you have to synchronize the channels of the devices.

For information on automatic synchronization of the bodypack transmitter with the receiver (individual operation), refer to the instruction manual of the receiver. This information is marked with the **sync** icon.

Alternatively, you can set the channel on the bodypack transmitter manually:

- ▶ Make sure that you set the bodypack transmitter to the same frequency bank and the same channel as the receiver (see page 22).

If you still cannot establish a transmission link, refer to the chapter “If a problem occurs ...” on page 32.

### Synchronizing bodypack transmitters with receivers – multi-channel operation

Combined with ew 300 G3 receivers, ew 300 G3 bodypack transmitters can form transmission links that can be used in multi-channel systems.

For information on automatic synchronization of bodypack transmitters with receivers (multi-channel operation), refer to the instruction manual of your receiver.

For more information on multi-channel operation, visit the SK 300 G3 product page at [www.sennheiser.com](http://www.sennheiser.com).

# Cleaning the bodypack transmitter

---

**CAUTION!** Liquids can damage the electronics of the bodypack transmitter!

Liquids entering the housing of the device can cause a short-circuit and damage the electronics.

▶ Keep all liquids away from the bodypack transmitter.

- 
- ▶ Use a cloth to clean the bodypack transmitter from time to time.
  - ▶ Do not use any solvents or cleansing agents.



# Recommendations and tips

## ... for the ME 2 and ME 4 clip-on microphones

- To reduce level variations to a minimum when the user turns his or her head away from the microphone, attach the microphone as centrally as possible.
- To protect the microphone against excessive sweat/moisture, avoid direct skin contact.
- Attach the microphone carefully and conduct the cable so that noise due to friction is avoided.
- Always use the ME 4 directional microphone with a windshield and direct the microphone towards the sound source (e.g. mouth).

## ... for the ME 3 headmic

- Always use the microphone with a pop shield and position the microphone at the corner of the mouth.
- You can vary the bass reproduction by increasing/decreasing the talking distance.
- Make sure that the sound inlet is directed towards the mouth. The sound inlet is marked with a little dot.

## ... for the bodypack transmitter

- Make sure that the antenna and the microphone cable do not cross.
- The antenna should hang freely and be at least 1 cm away from the body. The antenna must not be in direct contact with the skin.
- For best results, make sure that the transmitter sensitivity is correctly adjusted.

## ... for optimum reception

- Transmission range depends to a large extent on location and can vary from about 10 m to about 150 m. There should be a "free line of sight" between transmitting and receiving antennas.
- To avoid overloading the receiver, observe a minimum distance of 5 m between transmitting and receiving antennas.

## ... for multi-channel operation

- For multi-channel operation, you should only use the channels within one frequency bank. Each of the frequency banks "1" to "20" accommodates factory-preset frequencies which are intermodulation-free.
- When using several transmitters simultaneously, interference can be avoided by maintaining a minimum distance of 20 cm between two transmitters.

## If a problem occurs ...

Problem	Possible cause	Possible solution
Bodypack transmitter cannot be operated, "Locked" appears on the display panel	Lock mode is activated	Deactivate the lock mode (see page 13).
No operation indication	Batteries are flat or accupack is flat	Replace the batteries or recharge the accupack (see page 8).
No RF signal at the receiver	Bodypack transmitter and receiver are not on the same channel	Set the bodypack transmitter to the same channel as the receiver.
		Synchronize the bodypack transmitter with the receiver (see page 21).
	Transmission range is exceeded	Reduce the distance between bodypack transmitter and receiving antennas.
		Increase the transmission power (see page 26).
	RF signal is deactivated ("RF Mute")	Activate the RF signal (see page 14).
RF signal available, no audio signal, "MUTE" appears on the display panel	Bodypack transmitter is muted (MUTE)	Cancel the muting (see page 14).
	Receiver's squelch threshold is adjusted too high	Reduce the squelch threshold setting on the receiver.
	Bodypack transmitter doesn't transmit a pilot tone	Activate or deactivate the pilot tone transmission (see page 27).
Audio signal has a high level of background noise or audio signal is distorted	Bodypack transmitter's sensitivity is adjusted too low/too high	Adjust the input sensitivity (see page 21).

If a problem occurs that is not listed in the above table or if the problem cannot be solved with the proposed solutions, please contact your local Sennheiser partner for assistance.

To find a Sennheiser partner in your country, search at [www.sennheiser.com](http://www.sennheiser.com) under "Service & Support".

# Specifications

## RF characteristics

Modulation	wideband FM
Frequency ranges	516–558, 566–608, 606–648, 626–668, 734–776, 780–822, 823–865 MHz (A–E, G, GB, see page 3)
Transmission frequencies	1,680 frequencies, tuneable in steps of 25 kHz  20 frequency banks, each with up to 24 factory-preset channels  6 frequency banks, each with up to 24 user programmable channels
Switching bandwidth	42 MHz
Nominal/peak deviation	$\pm 24$ kHz/ $\pm 48$ kHz
Frequency stability	$\leq \pm 15$ ppm
RF output power at 50 $\Omega$ , switchable	typ. 10 mW (low) typ. 30 mW (standard)
Pilot tone squelch	can be switched off

## AF characteristics

Compander system	Sennheiser <a href="#">HDX</a>
AF frequency response	microphone: 80–18,000 Hz  line: 25–18,000 Hz
Signal-to-noise ratio (1 mV, peak deviation)	$\geq 115$ dBA
THD	$\leq 0.9\%$
Max. input voltage microphone/line	3 $V_{\text{rms}}$
Input impedance microphone/line	40 k $\Omega$ , unbalanced/1 M $\Omega$
Adjustment range of input sensitivity	60 dB, adjustable in 3-dB steps

## Overall device

Temperature range	$-10^{\circ}\text{C}$ to $+55^{\circ}\text{C}$
Power supply	2 AA size batteries, 1.5 V or BA 2015 accupack
Nominal voltage	2.4 V $\approx$

## Specifications

### Current consumption:

at nominal voltage	typ. 180 mA (30 mW)
with switched-off transmitter	$\leq 25 \mu\text{A}$

### Operating time

typ. 8 hrs

### Dimensions

approx. 82 x 64 x 24 mm

### Weight (incl. batteries)

approx. 160 g

## In compliance with

### Europe



EMC	EN 301489-1/-9
Radio	EN 300422-1/-2
Safety	EN 60065 EN 62311 (SAR)

## Approved by

### Canada

Industry Canada RSS 123  
IC 2099A-G3SK  
limited to 698 MHz

### USA

FCC-Part 74  
FCC-ID: DMO G3SK  
limited to 698 MHz

## Microphones

	ME 2	ME 3	ME 4
Microphone type	condenser	condenser	condenser
Sensitivity	20 mV/Pa	1.6 mV/Pa	40 mV/Pa
Pick-up pattern	omni	cardioid	cardioid
Max. SPL	130 dB SPL	150 dB SPL	120 dB SPL

## Connector assignment

3.5 mm jack plug:

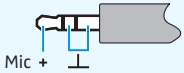
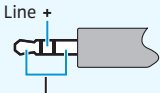
Mic	Line
	

# Polar diagrams and frequency response curves of the microphones

Polar diagram ME 3

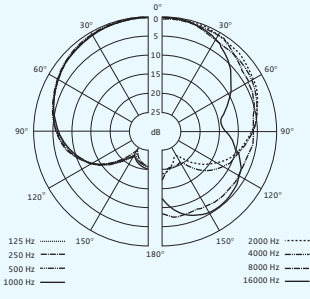

Polar diagram ME 4

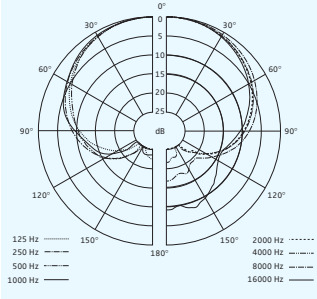

Frequency response curve ME 2

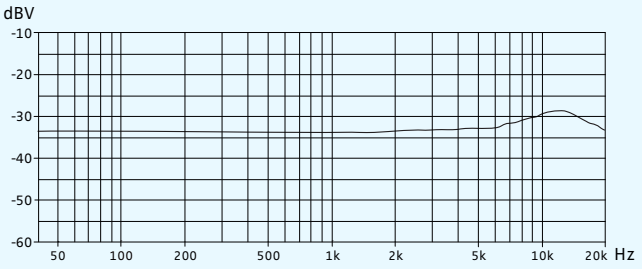

Frequency response curve ME 3

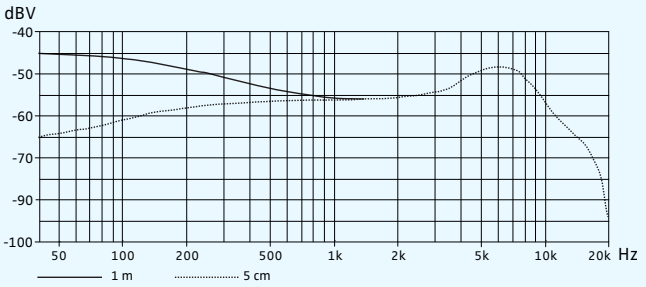

Frequency response curve ME 4

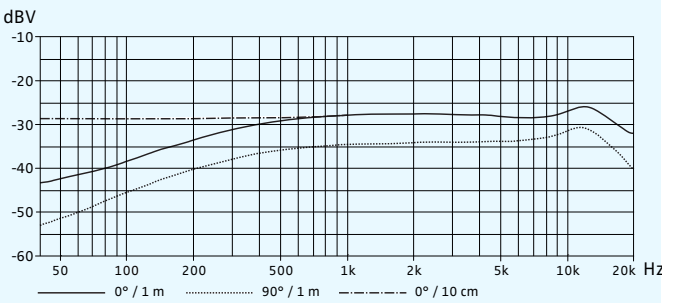



**Sennheiser electronic GmbH & Co. KG**

Am Labor 1, 30900 Wedemark, Germany

[www.sennheiser.com](http://www.sennheiser.com)

Publ. 12/16, 549126