

Tourguide Charger L 2021-40



Contents

Important safety instructions	2
Delivery includes	4
The L 2021-40 charger	4
Product overview	5
Indications and displays on the charger	6
Putting the charger into operation	7
Placing the charger on a table or cabinet	7
Installing the charger	8
Connecting the charger to a PC	10
Connecting the charger to and disconnecting it from the mains	10
Using the charger	11
Switching the charger on/off	11
Charging the receiver rechargeable batteries	12
Cleaning the L 2021-40	14
Specifications	14
Accessories for the Tourguide system	15
Manufacturer Declarations	16

Thank you for choosing Sennheiser!

We have designed this product to give you reliable operation over many years. Over 60 years of accumulated expertise in the design and manufacture of high-quality electro-acoustic equipment have made Sennheiser a world-leading company in this field.

Please take a few moments to read these instructions carefully, as we want you to enjoy your new Sennheiser products quickly and to the fullest.

Important safety instructions

1. Read these instructions.
2. Keep these instructions. Always include these instructions when passing the device on to third parties.
3. Heed all warnings.
4. Follow all instructions.
5. Do not use the device near water.
6. Clean only with a dry cloth.
7. Do not block any ventilation openings. Install in accordance with these instructions.
8. Do not install near any heat sources such as radiators, heat registers, stoves, or other devices (including amplifiers) that produce heat.
9. The device should be operated only from the type of power source indicated on the mains plug. The device must only be connected to properly grounded power outlets.
10. Protect the mains cable from being walked on or pinched, particularly at plugs, convenience receptacles, and the point where it exits from the device.
11. Only use attachments/accessories specified by Sennheiser.
12. Use only with the cart, stand, tripod, bracket, or table specified by the manufacturer, or sold with the device.
When a cart is used, use caution when moving the cart/device combination to avoid injury from tip-over.
13. Unplug the device during lightning storms or when unused for long periods of time.
14. Refer all servicing to qualified service personnel.
Servicing is required if the device has been damaged in any way, such as mains cable or plug damage, liquid has been spilled, objects have fallen inside, the device has been exposed to rain or moisture, does not operate properly or has been dropped.
15. To completely disconnect the device from the AC mains, disconnect the mains plug from the AC receptacle.
16. **WARNING:** To reduce the risk of fire or electric shock, do not expose the device to rain or moisture.
17. Do not expose the device to dripping or splashing and ensure that no objects filled with liquids, such as vases or coffee cups, are placed on the device.
18. The plug of the mains cable shall remain readily operable and easily accessible.





Hazard warnings on the rear of the charger

The label shown on the left is attached to the rear of the charger. The symbols on this label have the following meaning:

This symbol is intended to alert the user to the presence of uninsulated dangerous voltage within the device's enclosure that may be of sufficient magnitude to constitute risk of fire or electric shock.

This symbol is intended to alert the user to the risk of electric shock if the device is opened. There are no user serviceable parts inside. Refer servicing to qualified personnel only.

This symbol is intended to indicate the presence of important operating and maintenance instructions in the literature accompanying this device.

Overloading

Do not overload wall outlets and extension cables as this may result in fire and electric shock.

If you switch on several chargers at the same time, you can blow the fuse due to the high switch-on voltage! Therefore, never switch on more than three chargers at the same time, e.g. via a switchable multi-outlet power strip.

Replacement parts

When replacement parts are required, be sure the service technician uses used replacement parts specified by Sennheiser or those having the same characteristics as the original part. Unauthorized substitutions may result in fire, electric shock, or other hazards.

Safety check

Upon completion of any service or repairs to this device, ask the service technician to perform safety checks to determine that the device is in a safe operating condition.

Intended use of the device

Intended use of the device includes:

- using the device for professional purposes,
- having read these instructions especially the chapter "Important safety instructions" on page 2,
- using the device within the operating conditions and limitations described in this instruction manual.

"Improper use" means using the device other than as described in this instruction manual, or under operating conditions which differ from those described herein.

Delivery includes

- 1 L 2021-40 charger
- 1 CD-ROM with:
 - the instruction manual of the L 2021-40 charger
 - the “Conference Control” software
 - the instruction manual of the “Conference Control” software

You additionally require:

- 1 mains cable
- 1 network cable

The L 2021-40 charger

The L 2021-40 charger is part of the Tourguide 2020 D system. The Tourguide 2020 D system offers optimum digital speech transmission for guided tours e.g. in factories or museums and during conferences. The use of RF transmission allows freedom of movement for all members of the group. Six fixed transmission frequencies in “Tourguide mode” and eight transmission frequencies in “Conference mode” offer high flexibility and adaptability. The L 2021-40 charger can charge a total of 40 HDE 2020 D and/or EK 2020 D receivers with their built-in rechargeable batteries. The channel copy function lets you set all receivers to the same channel at the press of a button.

In addition, the charger allows you to directly configure the receivers via a PC. You can connect up to 125 chargers to a single PC, allowing you to simultaneously configure up to 5000 receivers.

Additional features of the charger:

- Quick charge of receiver rechargeable batteries
- Highest possible operational reliability, since temperature and voltage of the rechargeable batteries are monitored during charging

Product overview

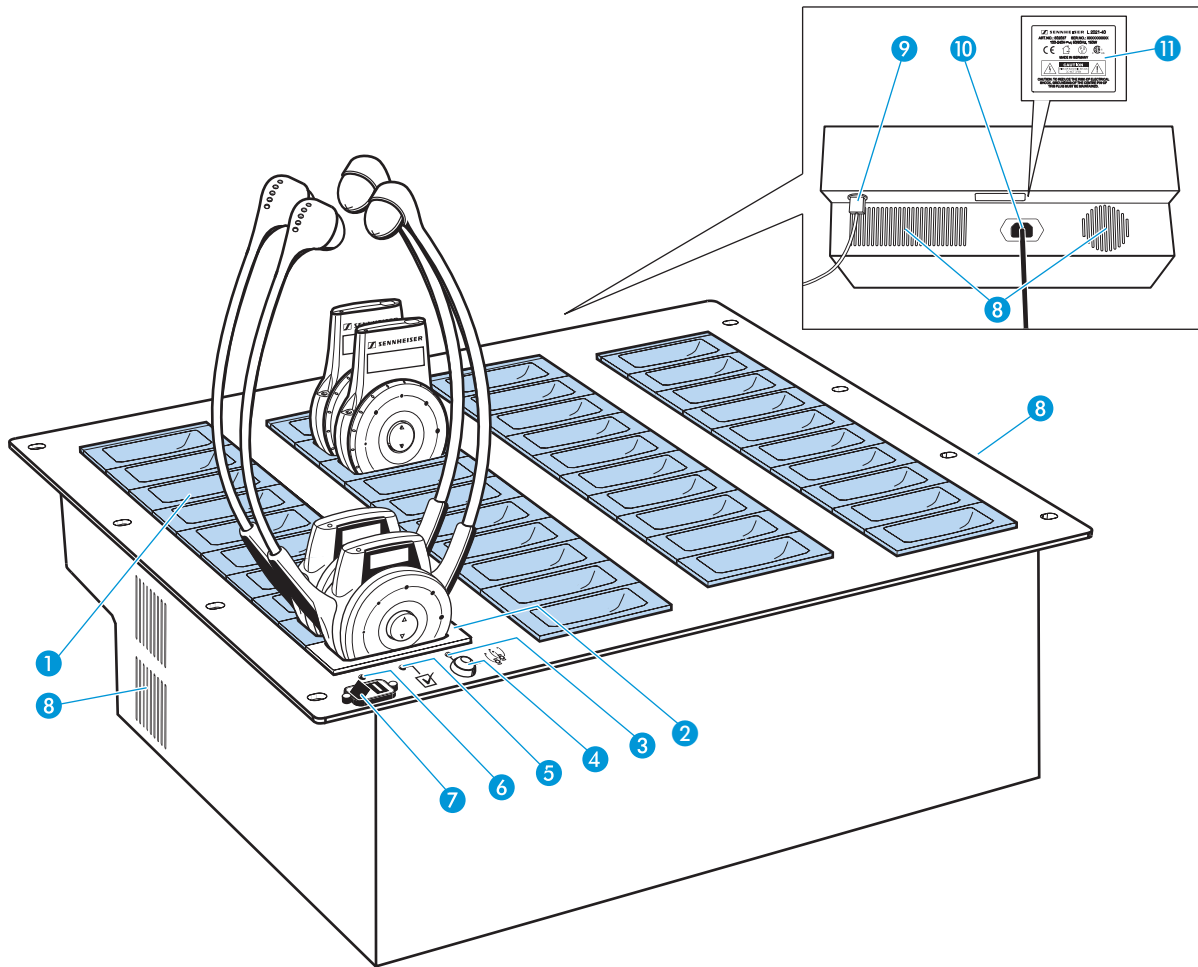

- ① 39 "slave" charging compartments (light blue in the diagram)
- ② "Master" charging compartment (with channel copy function)
- ③ Green LED COPY AVAILABLE
- ④ COPY button
- ⑤ Yellow LED SELECT
- ⑥ Red LED POWER
- ⑦ Mains switch
- ⑧ Air vents
- ⑨ Network socket
- ⑩ Mains socket
- ⑪ Type plate

Indications and displays on the charger

Operation indication

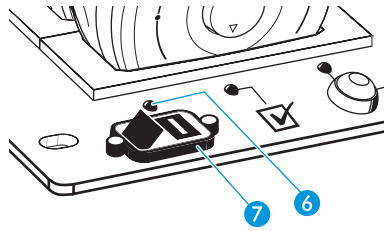

LED POWER 6	Meaning
lights up red	The mains switch 7 is in position "I", the mains supply is switched on.
is off	The mains switch 7 is in position "0", the mains supply is switched off.

Status indication

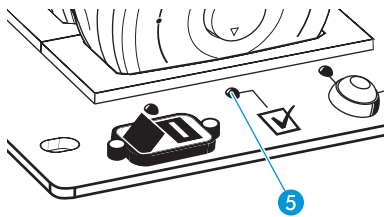

LED SELECT 5	Meaning
flashes yellow	You have just switched on the device (LED flashes for a maximum of 2 seconds) or an error has occurred.
lights up yellow	The charger is connected to a PC and the "Conference Control" software is running and has established a network connection with the charger and you have selected the charger or at least one receiver placed into the charger via the "Conference Control" software.
is off	Neither the charger nor a receiver have been selected via the "Conference Control" software.

LED indication for "automatic copying" function

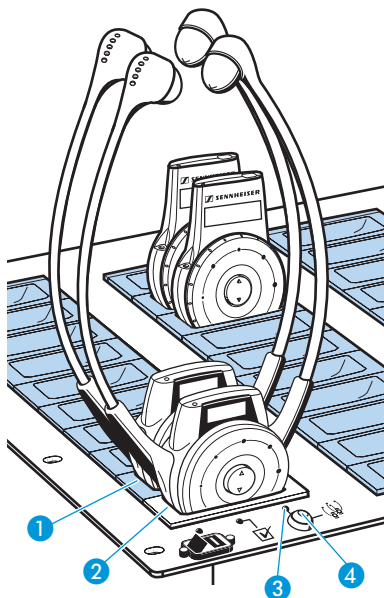

LED COPY AVAILABLE 3	Meaning
lights up green	The "automatic copying" function is available (see below).
if off	The "automatic copying" function is not available (see below).

When the "automatic copying" function is available, the green LED **COPY AVAILABLE 3** lights up. This is the case when:

- at switch-on of the charger, a receiver is already placed into the "master" charging compartment 2 or you place a receiver into the "master" charging compartment 2 or you switch on a receiver that is already placed into the "master" charging compartment 2 and
- at least one receiver is placed into one of the "slave" charging compartments 1 and
- no network connection exists.

When the "automatic copying" function is not available, the green LED **COPY AVAILABLE 3** goes off. This is the case when:

- you remove the receiver from the "master" charging compartment 2 or
- all "slave" charging compartments 1 are empty or
- the "Conference Control" software accesses the charger or
- you do not press the **COPY** button 4 within two minutes.

Putting the charger into operation

CAUTION! Danger due to heat accumulation!

The charger and the receiver rechargeable batteries can get very hot during charging. If the heat cannot dissipate, the devices can be damaged.

- ▶ Make sure that the air vents of the charger are not covered or blocked.
 - ▶ Provide sufficient ventilation so that the maximum ambient temperature of the charger does not exceed 40°C.
 - ▶ Keep the charger away from heat sources and never expose it to direct sunlight.
-

The charger can be:

- placed on a table or cabinet
- installed in a 19" rack
- installed in a cabinet or similar

When using the "Conference Control" software, it automatically sorts all charger displays according to ascending serial numbers. The assignment of the charger displays of the software to the chargers becomes easier and clearer if you install the chargers according to ascending serial numbers.

Placing the charger on a table or cabinet

The charger has four plastic feet to ensure that it cannot slip on the surface on which it is placed.

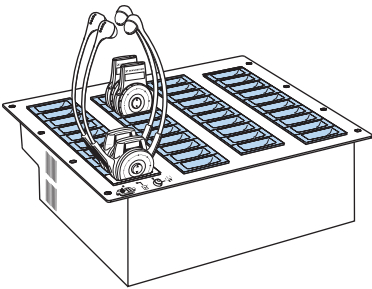

CAUTION! Risk of staining of furniture surfaces!

Some furniture surfaces have been treated with varnish, polish or synthetics which might cause stains when they come into contact with other synthetics. Despite a thorough testing of the synthetics used by us, we cannot rule out the possibility of staining.

- ▶ Do not place the charger on delicate surfaces.
-

- ▶ Place the charger on a table, cabinet or similar.

Installing the charger

The housing of the charger is designed so that it fits into a 19" rack. The charger can also be installed in a cabinet or similar.

CAUTION! Risks when rack mounting the charger!



When installing the device in a closed or multi-rack assembly, please consider that, during operation, the ambient temperature, the mechanical loading and the electrical potentials will be different from those of devices which are not mounted into a rack.

- ▶ The ambient temperature within the rack, cabinet or similar must not exceed the temperature limit specified in the specifications.
- ▶ When installing the device, take good care not to affect the ventilation required for safe operation. If necessary, provide additional ventilation.
- ▶ Make sure the mechanical loading of the rack is even to avoid a hazardous condition.
- ▶ When connecting the device to the power supply, observe the information indicated on the type plate. Avoid circuit overloading. If necessary, provide overcurrent protection.
- ▶ Ensure a reliable mains ground connection of the device by taking appropriate measures – especially when you are using an extension cable or a multi-outlet power strip.
- ▶ When installing the device in a closed or multi-rack assembly, please note that intrinsically harmless leakage currents of the individual devices may accumulate, thereby exceeding the allowable limit value. As a remedy, ground the rack via an additional ground connection.

-
- ▶ Use eight screws to fasten the charger.

You can install the charger fixedly, e.g. in a cabinet or similar. For the dimensions required for fixed installation, please refer to the below installation drawing.

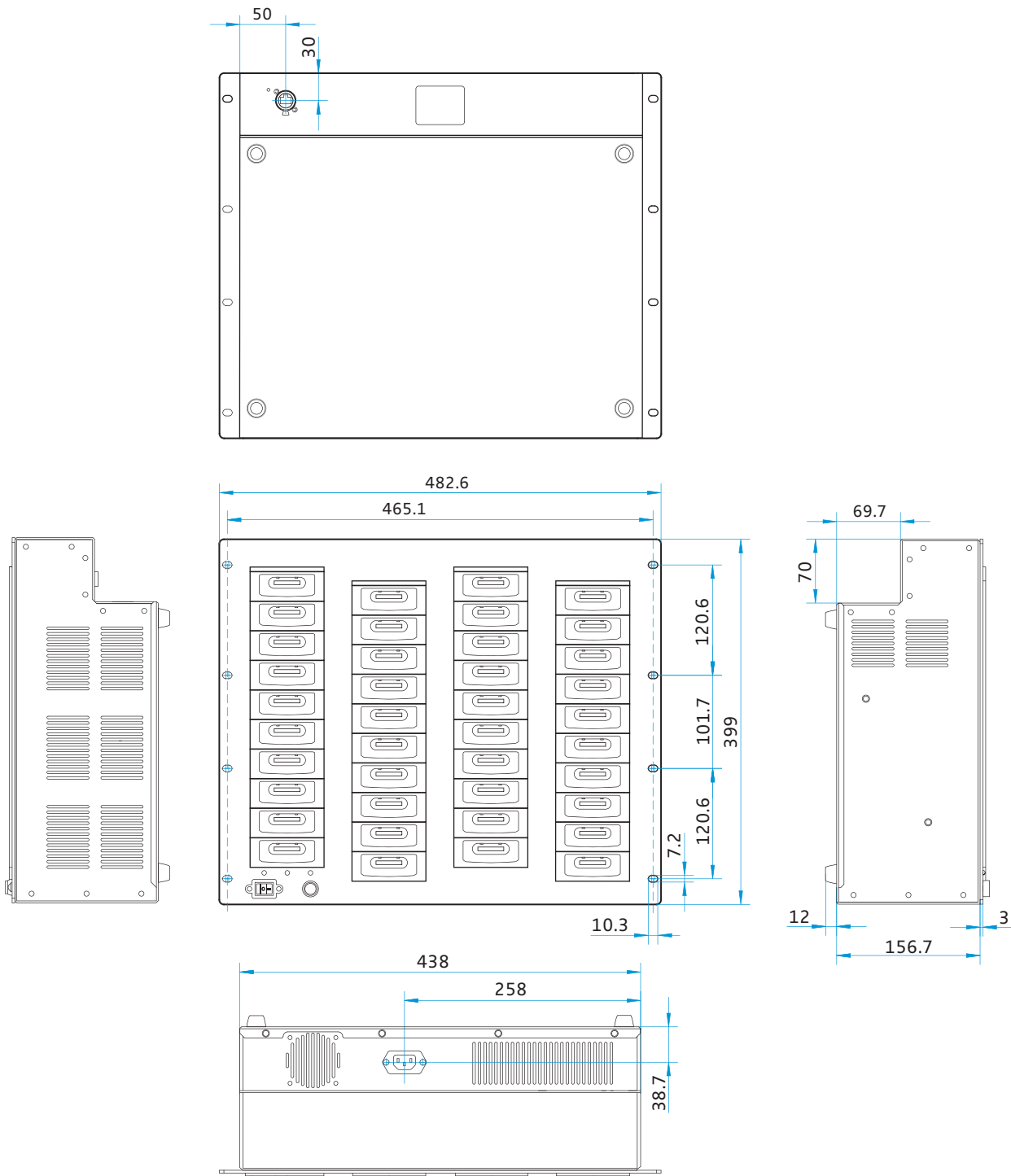

Connecting the charger to a PC

You can connect one or several chargers to a PC. The supplied "Conference Control" software allows you to centrally and easily configure and monitor several chargers and receivers.

For this, the charger requires a network connection with a PC. The charger can be connected directly to an individual PC or integrated into an existing network. The charger cannot communicate with several PCs at the same time.

The charger also functions without connection to a PC.

Connecting the network cable

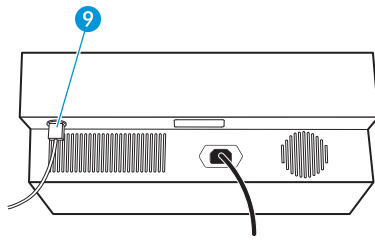

- ▶ Use a standard network cable (RJ45 CAT.5E, to be ordered separately) to connect the network socket 9 and an Ethernet socket of the network.
- ▶ Install the "Conference Control" software.
- ▶ Configure the network communication between the "Conference Control" software and the charger (see the instruction manual of the "Conference Control" software on the enclosed CD).

Connecting the charger to and disconnecting it from the mains

CAUTION! Danger due to electric current!

If you connect the charger to an unsuitable power supply, this can cause damage to the device!

- ▶ Use a mains cable with a 3-pin IEC mains connector to ensure a reliable mains ground connection of the charger – especially when you are using an extension cable or a multi-outlet power strip.
 - ▶ Avoid circuit overloading. If necessary, provide overcurrent protection.
-

To connect the charger to the mains:

- ▶ Connect a mains cable (to be ordered separately) to the mains socket 10.
- ▶ Plug the mains connector into a wall socket.

To disconnect the charger from the mains:

- ▶ Pull out the mains connector from the wall socket.

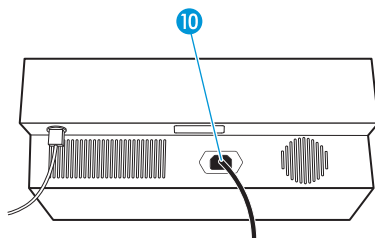

Using the charger

Switching the charger on/off

CAUTION! High switch-on voltage can blow the fuse!

If you switch on more than three chargers at the same time, you can blow the fuse due to the high switch-on voltage!

- ▶ Only switch on a maximum of three chargers at the same time, e.g. via a switchable multi-outlet power strip.
-

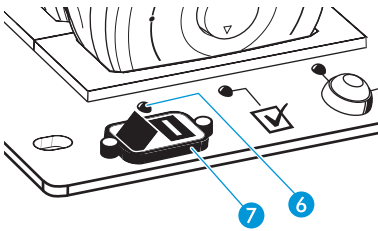

To switch the charger on:

- ▶ Set the mains switch **7** to position "I".
The red LED **POWER 6**  lights up. The rechargeable batteries of the receivers in the charger are recharged. The "Conference Control" software detects the charger in the network.

To switch the charger off:

- ▶ Set the mains switch **4** to position "0".
The red LED **POWER 6**  goes off. The charger is disconnected from the mains. The rechargeable batteries of the receivers in the charger are no longer recharged. The "Conference Control" software does not detect the charger in the network.

If you do not use the charger for extended periods of time:

- ▶ Disconnect the charger from the mains by setting the mains switch **7** to position "0" or pulling out the mains connector from the wall socket.
The red LED **POWER 6**  goes off.

Charging the receiver rechargeable batteries

CAUTION! Danger of damage to the receivers due to over-heating!

The receivers' built-in rechargeable batteries can get very hot during charging and thus be damaged!

- ▶ Only use the charger for charging the rechargeable batteries of the HDE 2020 D and EK 2020 D receivers. For more information on the HDE 2020 D and EK 2020 D receivers with their built-in Lithium-Polymer rechargeable batteries, refer to the detailed instruction manual.
- ▶ Never try to charge other rechargeable batteries or non-rechargeable batteries in the charger!

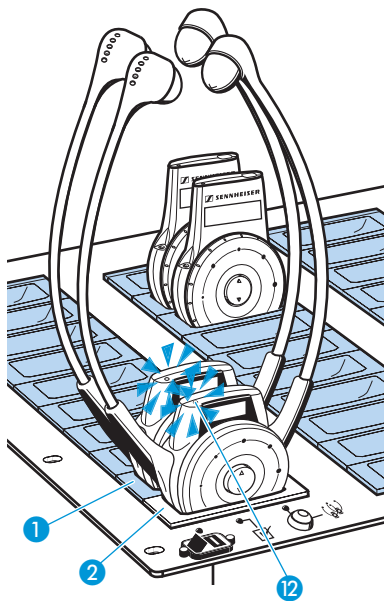

- ▶ Place the receiver into any charging compartment. The LED 12 on the receiver indicates the charge status.

LED 12	Meaning
lights up red	The rechargeable battery is being charged.
lights up green	The rechargeable battery is fully charged.
flashes red	The temperature of the rechargeable battery is below 3°C or over 40°C. The charging process will be interrupted until the temperature of the rechargeable battery is again between 3°C and 40°C.
lights up orange	The rechargeable battery is defective. Interrupt the charging process and contact your Sennheiser service partner.
is off	The receiver is not placed correctly into the charging compartment.

Charging time of a completely discharged rechargeable battery at room temperature:

Receiver	Charging time
HDE 2020 D	approx. 2.5 hours
EK 2020 D	approx. 5 hours

The charging process may take longer if:

- the rechargeable battery is deep discharged and first has to be reconditioned by a deep discharge recovery charge,
- the temperature of the built-in rechargeable battery is below 3°C or over 40°C, since, in order to protect the rechargeable battery, the charging process will be interrupted until the temperature is again within the permissible range and the LED 12 lights up,
- the additional temperature protection of the charger interrupts the charging process until the charger has cooled down.

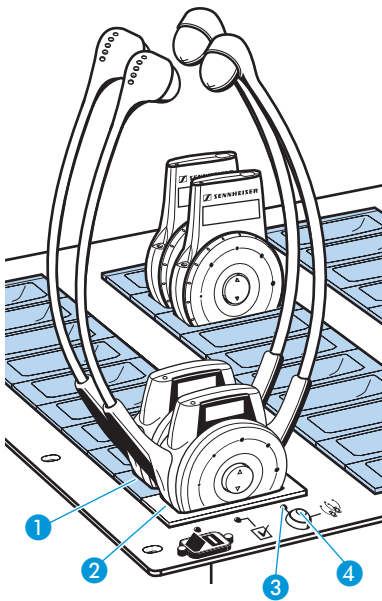

Setting the receiver channel(s) using the channel copy function

You can simultaneously set all receivers in the charger to the same channel. The channel copy function allows you to copy the current channel of the receiver placed into the “master” charging compartment **2** to all other receivers in the charger.

- ▶ Place all receivers which are to be set to the same channel into the “slave” charging compartments **1** (light blue in the diagram).
- ▶ Place the receiver whose channel you want to copy into the “master” charging compartment **2**.
The LED **COPY AVAILABLE** **3** lights up green as long as the channel copy function is available (see “LED indication for “automatic copying” function” on page 6).

Tip:

If you do not press the **COPY** button **4** within 2 minutes, the LED **COPY AVAILABLE** **3** goes off and the “automatic copying” function is no longer available. To reactivate this function, remove the receiver from the “master” charging compartment **2** and place it back again.

- ▶ Press the **COPY** button **4** to start the channel copy function.
The LC displays **13** of all receivers which are successfully set to the same channel light up.

Configuring chargers via a PC

The “Conference Control” software offers additional possibilities to configure the receivers and to display the configurations in detail. The “Conference Control” software and the corresponding instruction manual are included on the supplied CD.

Using several Tourguide systems simultaneously

If you are using several Tourguide 2020 D systems to give more than one guided tour or one conference at the same time, the systems can interfere with one another. To prevent this happening, you have to set the simultaneously used systems (a system is one transmitter and any number of receivers) to different channels. For details on the use of Tourguide systems, refer to the overall system manual “Tourguide System 2020”.

Cleaning the L 2021-40

CAUTION! Liquids can damage the electronics of the product!

Liquids entering the housing of the product can cause a short-circuit and damage the electronics.

- ▶ Keep all liquids away from the product.
 - ▶ Do not use any solvents or cleansing agents.
-

- ▶ Before cleaning, disconnect the charger from the mains.
- ▶ Only clean the plastic surface of the charger using a dust-free and dry cloth.

Specifications

Ambient temperature during charging	+3°C to +40°C
Mains socket	3-pin, protection class I, as per IEC/EN 60320-1
Mains voltage	100 to 240 V~ (50 or 60 Hz)
Primary power consumption	max. 150 W
Charging voltage per charging compartment	typ. 5 V
Charging current per charging compartment	max. 400 mA
Charging time for HDE 2020 D	approx. 2.5 hours
Charging time for EK 2020 D	approx. 5 hours
In compliance with	<p>CE EMC EN 301489-1/-9 Radio EN 300422-1/-2 Safety EN 60065</p> <p>FC 47 CFR 15 subpart B</p>
Dimensions in mm (W × H × D)	approx. 483 × 399 × 172
Weight (empty)	approx. 8.8 kg

Accessories for the Tourguide system

Product name	Product description	Cat. No.
HDE 2020 D	Stethoset receiver	500543
HDE 2020 D-US	Stethoset receiver (US)	500544
–	Earbuds (black) for HDE 2020 D and HDE 2020 D-US stethoset receivers	037080
–	Earbuds (transparent) for HDE 2020 D and HDE 2020 D-US stethoset receivers	040949
EK 2020 D	Receiver	502035
EK 2020 D-US	Receiver	502036
EZT 3012	Induction loop	504061
GP 3000 L	Lanyard	005224
SK 2020 D	Bodypack transmitter	500548
SK 2020 D-US	Bodypack transmitter (US)	500549
EZL 2020-20 L	Charging case	500542
BA 2015	Accupack	009950
L 2015	Charger for two SK 2020 D bodypack transmitters or two BA 2015 accupacks	009828
CL 2	Microphone cable, 1.5 m	004840
CL 1	Connecting cable for external audio devices (line input), 52 cm	005022
ME 2-N	Clip-on microphone	005018
ME 4-N	Clip-on microphone	005020
MKE 2-EW GOLD	Clip-on microphone	009831
ME 3-N	Headmic	005019
HSP 2-EW	Headmic	009866
HSP 4-EW	Headmic	009867
HS 2-EW	Headmic	–
e 815	Cardioid hand-held microphone with connecting cable	009425
e 825 S	Cardioid hand-held microphone with connecting cable	004511
e 835	Cardioid hand-held microphone with connecting cable	004513
e 840	Cardioid hand-held microphone with connecting cable	009894
e 845	Super-cardioid hand-held microphone with connecting cable	004515
Mains cable EU	Mains cable with EU plug, 2.5 m, black	054324
Mains cable US	Mains cable with US plug, 2.5 m, black	054325
Mains cable UK	Mains cable with UK plug, 2.5 m, black	057256
“Conference Control” PC software	Software for monitoring and configuring L 2021-40 chargers and HDE 2020 D / EK 2020 D receivers	–

Manufacturer Declarations

Warranty

Sennheiser GmbH & Co. KG gives a warranty of 24 months on this product.

For the current warranty conditions, please visit our web site at www.sennheiser.com or contact your Sennheiser partner.

CE Declaration of Conformity



These devices are in compliance with the essential requirements and other relevant provisions of Directives 2004/108/EC and 2006/95/EC. The declaration is available on the internet site at www.sennheiser.com.

Statements regarding FCC and industry Canada

This device complies with Part 15 of the FCC Rules and with RSS-210 of Industry Canada. Operation is subject to the following two conditions:

1. This device may not cause harmful interference, and
2. this device must accept any interference received, including interference that may cause undesired operation.

This equipment has been tested and found to comply with the limits for a Class B digital device, pursuant to Part 15 of the FCC Rules. These limits are designed to provide reasonable protection against harmful interference in a residential installation. This equipment generates, uses and can radiate radio frequency energy and, if not installed and used in accordance with the instructions, may cause harmful interference to radio communications.

However, there is no guarantee that interference will not occur in a particular installation. If this equipment does cause harmful interference to radio or television reception, which can be determined by turning the equipment off and on, the user is encouraged to try to correct the interference by one or more of the following measures:

1. Reorient or relocate the receiving antenna.
2. Increase the separation between the equipment and receiver.
3. Connect the equipment into an outlet on a circuit different from that to which the receiver is connected.
4. Consult the dealer or an experienced radio/TV technician for help.

This class B digital apparatus complies with the Canadian ICES-003.

Warning: Changes or modifications made to this equipment not expressly approved by Sennheiser electronic Corp. may void the FCC authorization to operate this equipment.



Sennheiser electronic GmbH & Co. KG
Am Labor 1, 30900 Wedemark, Germany
www.sennheiser.com

Printed in Germany
Publ.07/2009
524164/A01